



(

)

PISTOCHE!

3

I.1	3
I.2	PISTOCHE.....	3

4

5

II.1	PISTOCHE.....	5
II.2 PISTOCHE –	6
II.3	8
II.4	9
II.5	, PISTOCHE.....	9

10

III-1	PISTOCHE	10
III-2	PISTOCHE	17
III-3	19
III-4	– 0,5	21
III-5	22
III-6	24

26

27

V-1	27
VIII.2	27
VIII.3	27
VIII.4	27
VIII.5	28

29

IX.1	29
IX.2	29

30

X.1	0,5 : 2	30
X.2	: 2	30
X.3	: 2 ; 1	30
X.4	: 1	31
XI.5	31



PISTOCHE!

I.1

Pistoche

0,5

, 450 / ²,

I.2

PISTOCHE

: 2,3 x 2,3

: 0,67

58 : 2320

58 : 2270

230 ² / 12 ³ / 5 AC

40

58

Pistoche

, 2

PEFC.





!

), (

,

,

:

- ;
- , ;
- , () , , ;
- , ,

Pistoche (,),

).

Pistoche - ,

:

- 3,5
- , (, , .)
-
- 12 3,5

II.1

PISTOCHE

1 ():
 : 0,4 x 0,4 x 0,6
 : 10
 :
 • 0,5
 •
 •
 •
 •
 •



2 ():
 : 2,30 x 0,61 x 0,45
 : 150
 :
 •
 •
 •
 •





1/2

II.2 PISTOCHE –

FILTRATION

101	2x35	-
		24

102	5x60	-
		95

103	4x35	-
		8

104	4x20	-
		24

105	4x20	-
		95

106	torx 6x25	-
		16

214	150	-
		6

219		-
		2

220		-
		4

300		-
		1

301		-
		1

302		-
		1

303		-
		1

304		-
		1

305		-
		1

306		-
		1

307		-
		1

308		-
		1

309		-
		2

310		-
		4

400		-
		2

401		-
		2

402		-
		8

403		-
		2

404		-
		6

500		-
		1

501		-
		4



200	2203x68x28	-
		2

201	2203x77x28	-
		2

202	2130x145x28	-
		2

203	2203x145x28	-
		14

204	IV 2204x132x28	-
		4

205	2076x86x28	-
		3

206	2203x127x28	-
		1

207	2187x74x28	-
		1

208	634x86x58	-
		6

209	535x86x58	-
		2

210	584x17x44	-
		6

211	485x17x44	-
		2

212	IV 2099x145x28	-
		4

213	1688 mm	-
		3

215	, 1988	-
		1

216	, 1988	-
		1

217	1980	-
		4

218		-
		1

405		-
		1

II.4

- Pistoche
- Pistoche
- Pistoche
- Pistoche

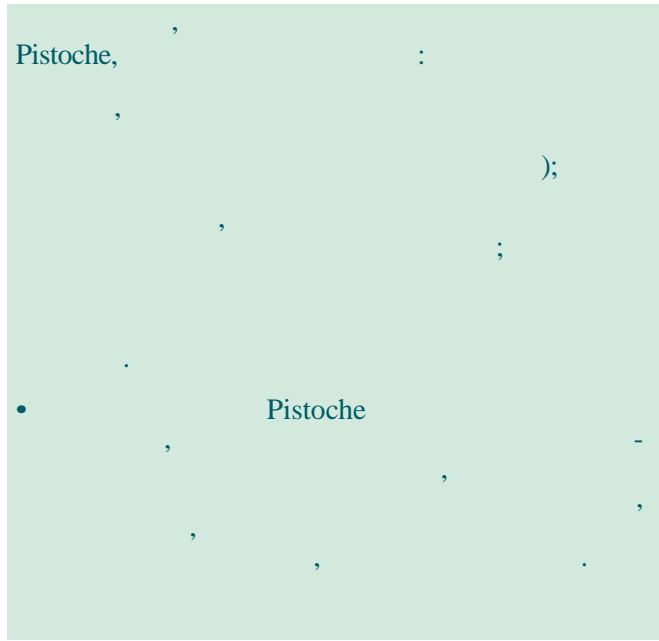

II.5 PISTOCHE

Pistoche;



III-1

PISTOCHE

201	×2
203	×2
204	×4

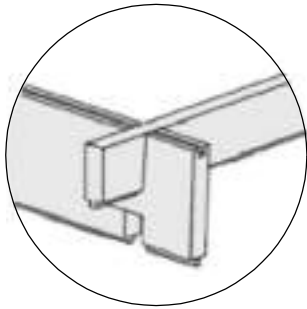

102	×12
-----	-----

5x60.

12

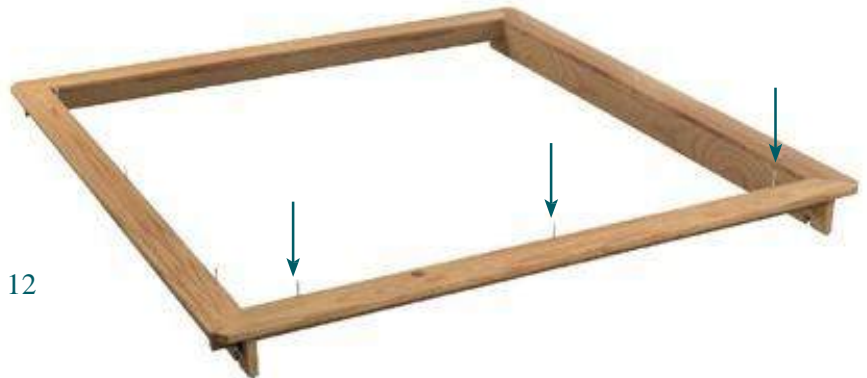

220	×4
106	×16





208	×6
209	×2
102	×16

(204)

(208 209)



(203).

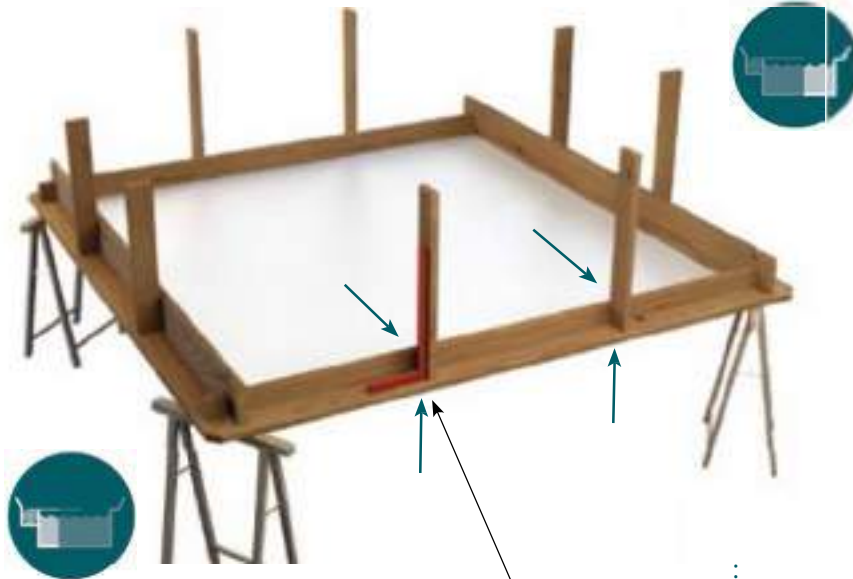

203 ×4

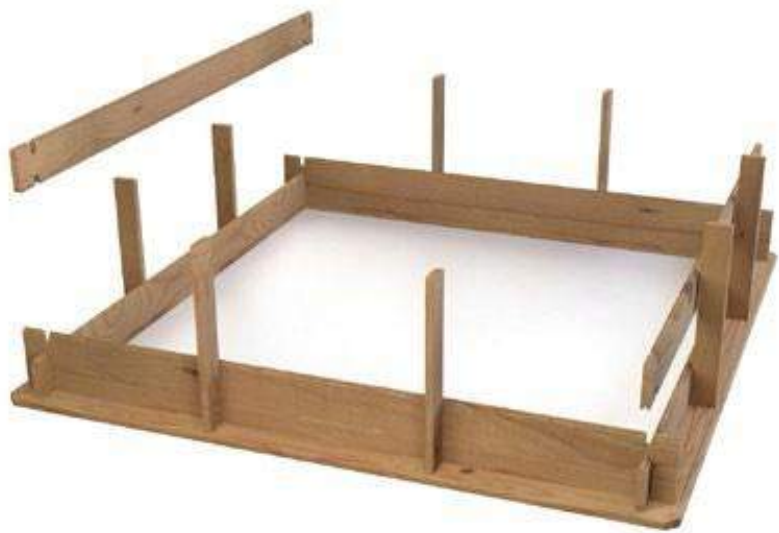

203 ×8
202 ×2



200 ×2





(208 209) -
(204).



102 x20

2
3

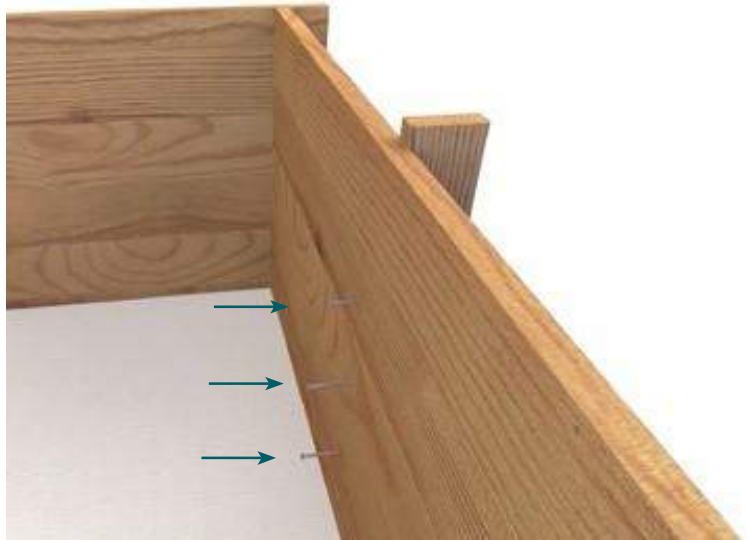



H 4-
Pistoche.

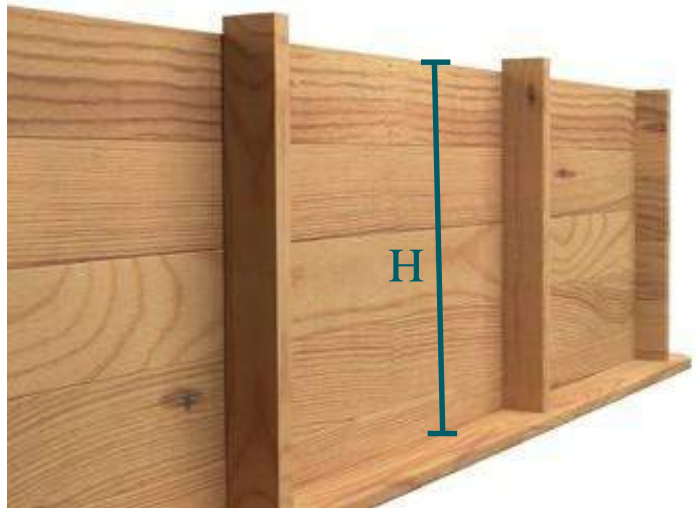

208 ×6

6 (634x86x58):

(203).



H 2,8
6

H

6

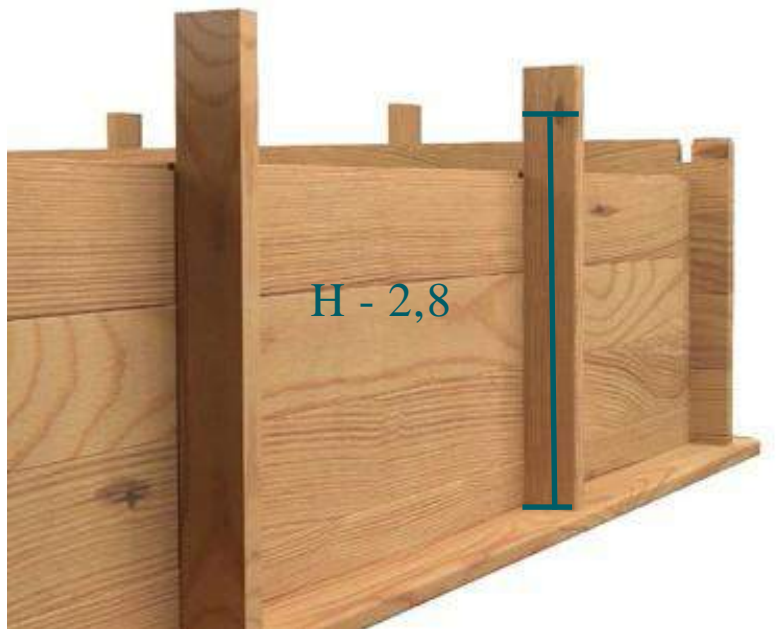

209 ×2

2 (535x86x58):

(200)
(203).



H 12,7

2





102 x12



205 x3
102 x15



(102):

(205)

(203)

(205)

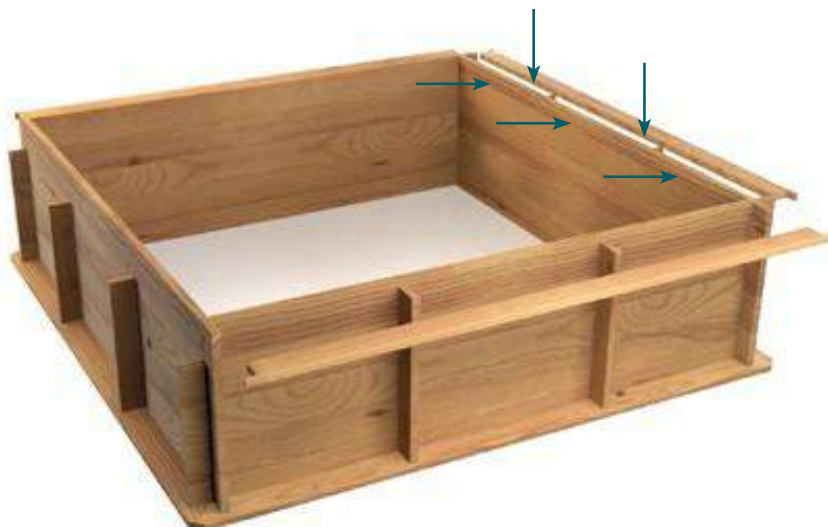



207 ×1
102 ×7

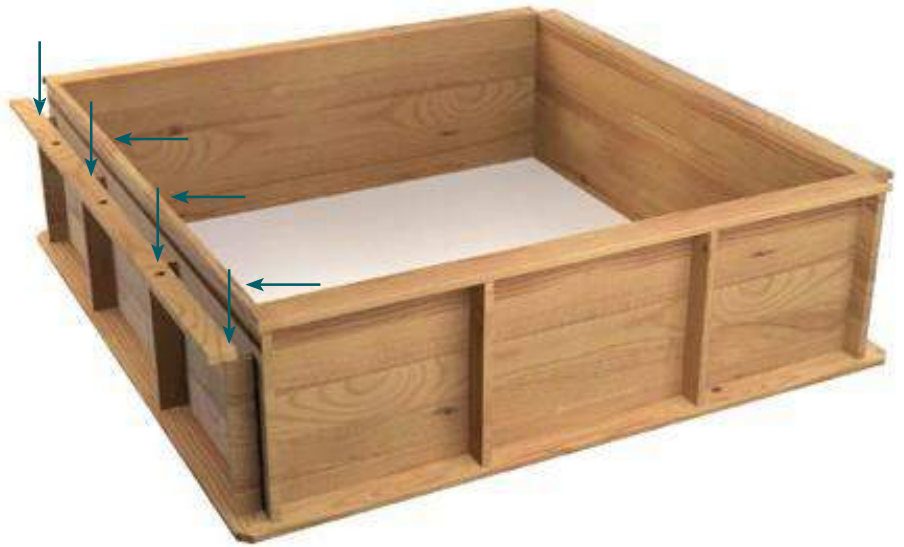

(203)

(207)

(207),

102 ×4

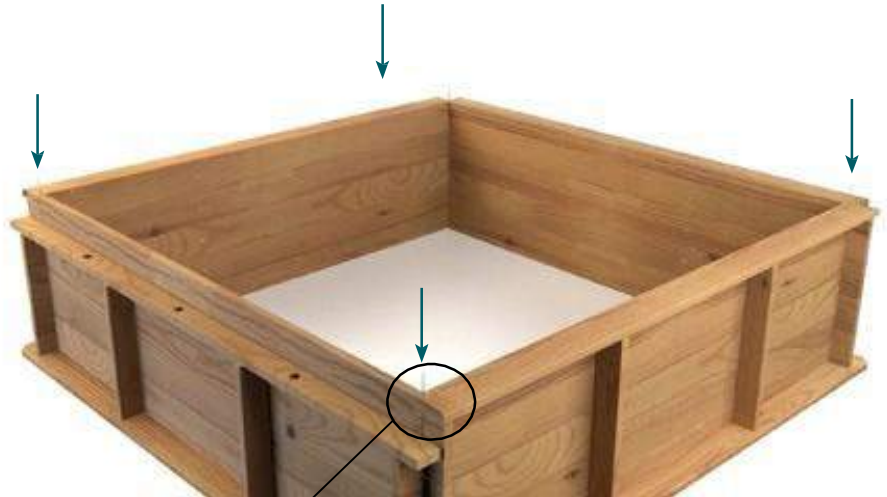

(102).

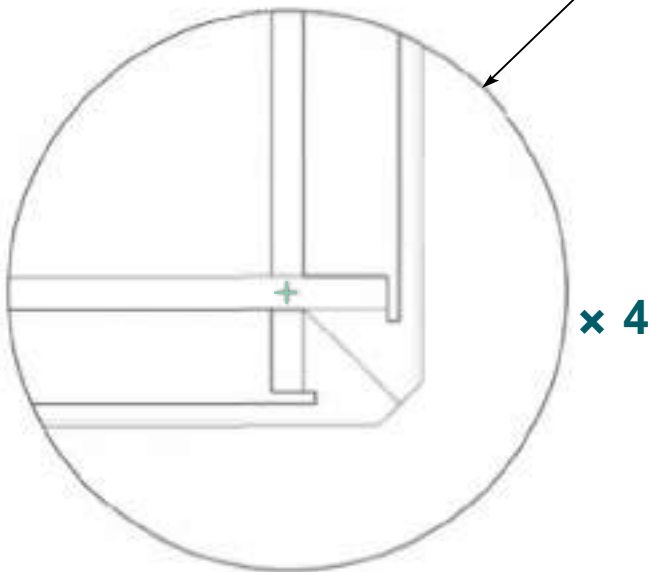

III-2



403	×2
104	×8

400	×1
103	×3

405	×1
-----	----

400	×1
103	×3

PISTOCHE

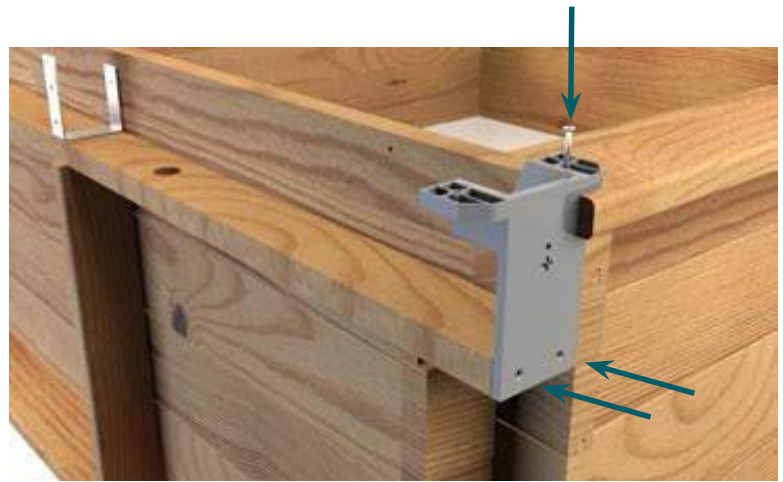



(403)

(104)

206	×1
102	×4
103	×2
104	×2

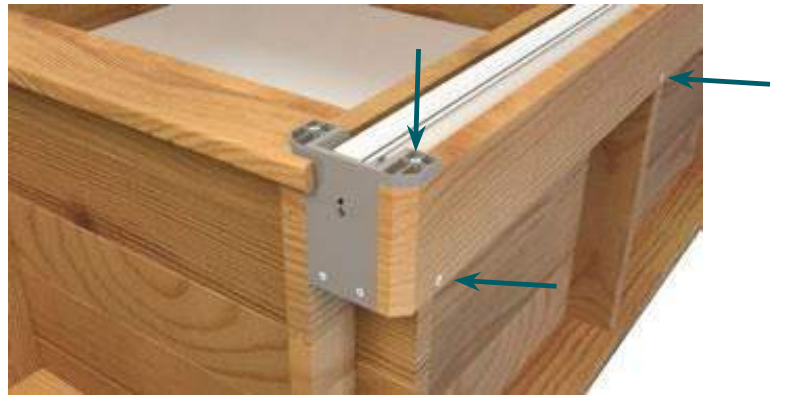

210	×6
211	×2
101	×24



15-

214	×6
105	×18

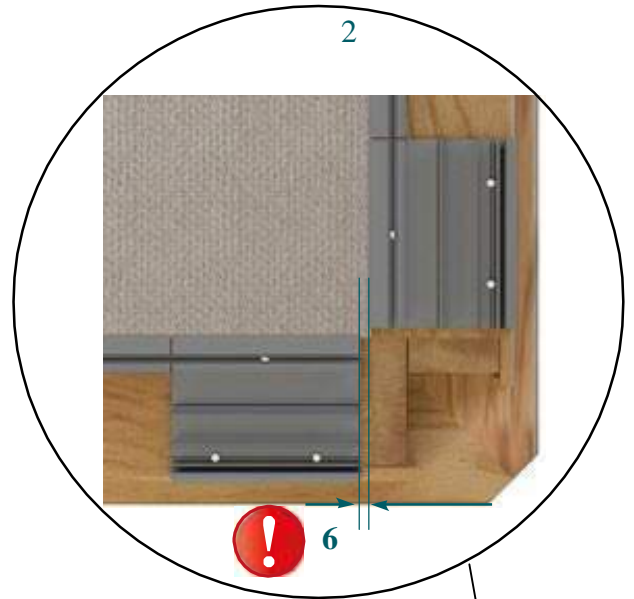
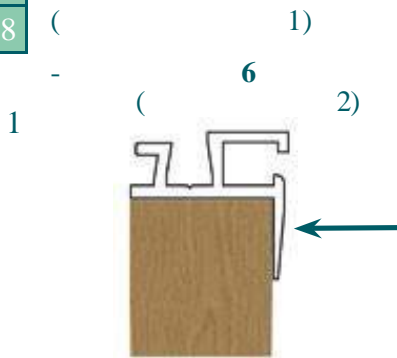

213	×3
105	×12

168,8-

(1)
15

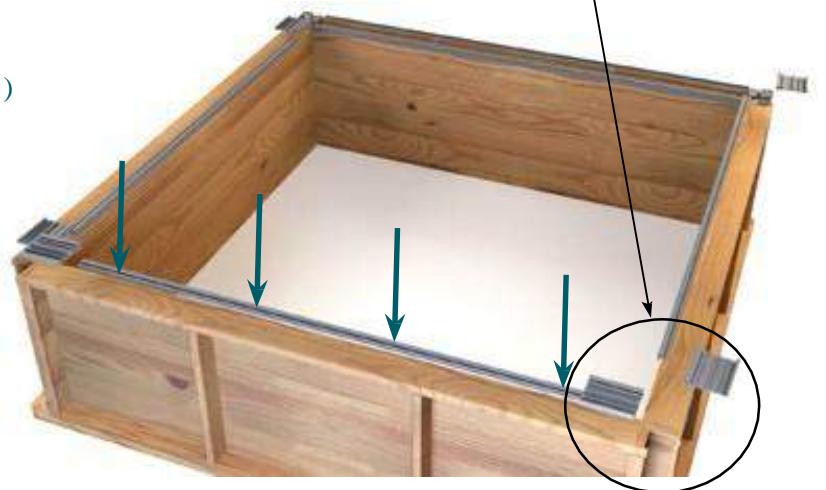

215	×1
216	×1
105	×8

107

(400).

III-3



_____ :

212	×1
217	×1
219	×2
105	×14

(217)



(212),

()



(219).



_____ :



(212), (217),



()

212	×1
217	×1
105	×8

_____ : Просверлите отверстия в алюминиевой полосе (217) согласно схеме ниже.



212	×2
217	×2
105	×16

_____ : Просверлите отверстия в алюминиевой полосе (217) согласно схеме ниже.

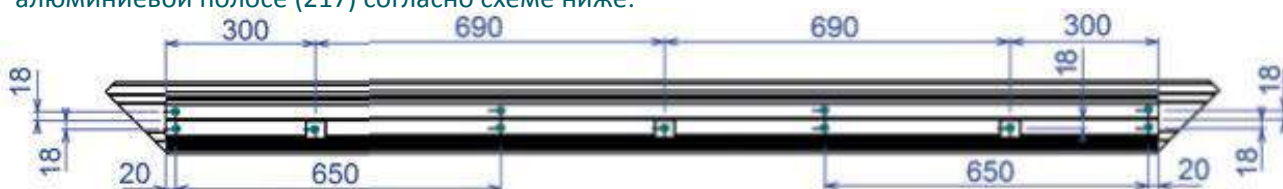

404	×6
104	×6



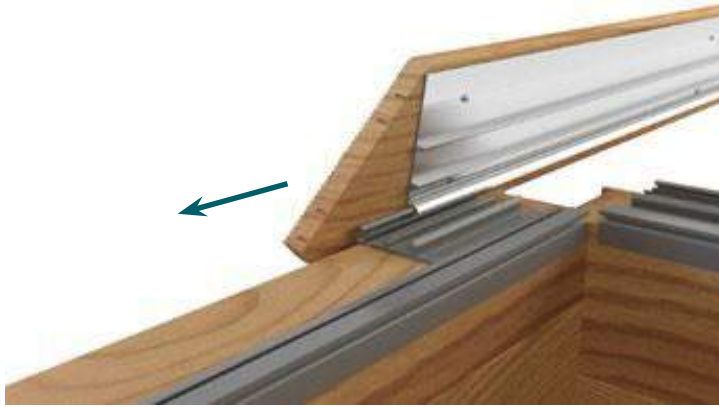

402	×8
105	×8

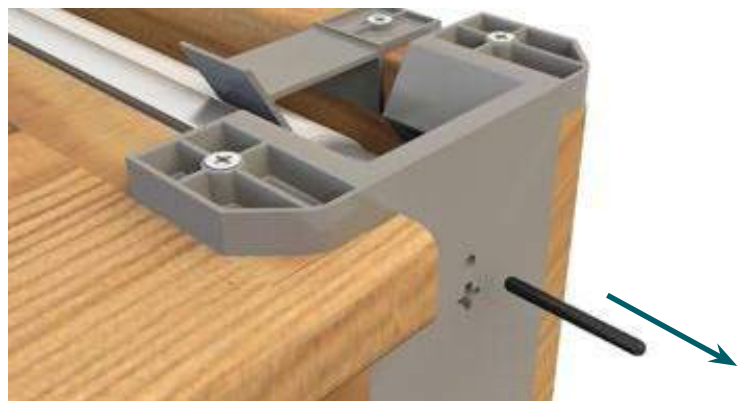

III-4

0,5



218	×1
500	×1



(213 216)



500	×1
-----	----

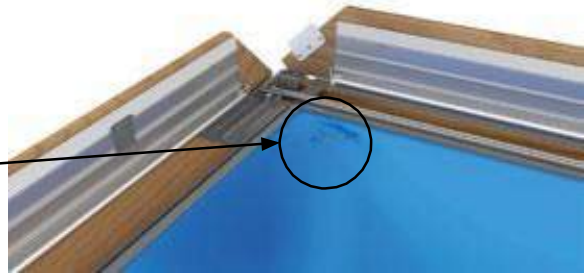

40 58



(24).

III-5

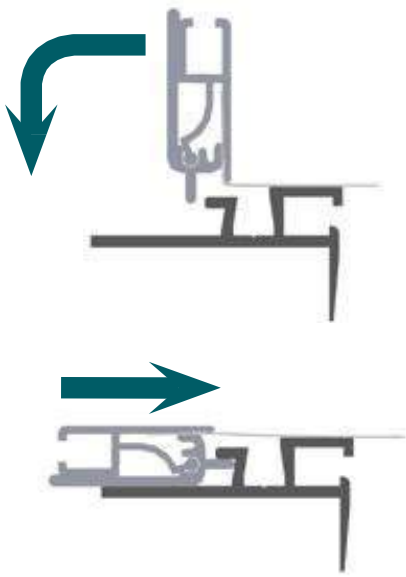

401	x2
104	x2



3



(213),

Pistoche.



III-6

- 301 ×1
- 302 ×1

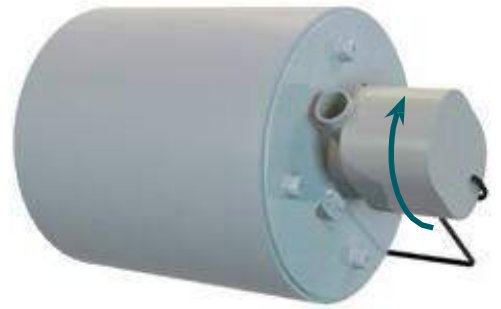
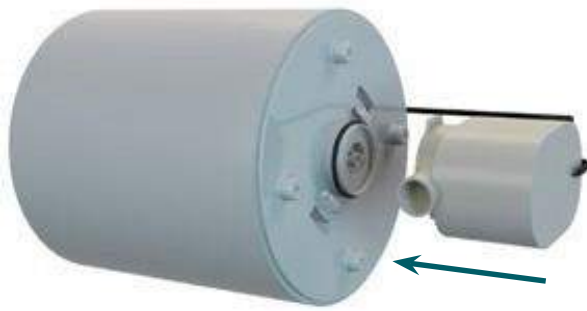

- 300 ×1
- 105 ×4



- 303 ×1

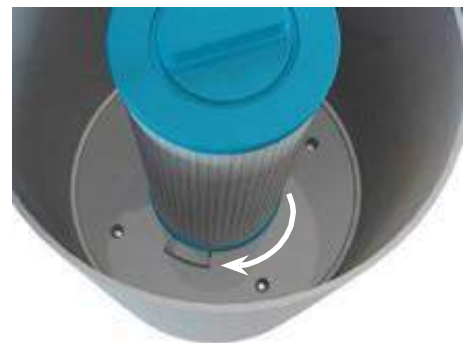
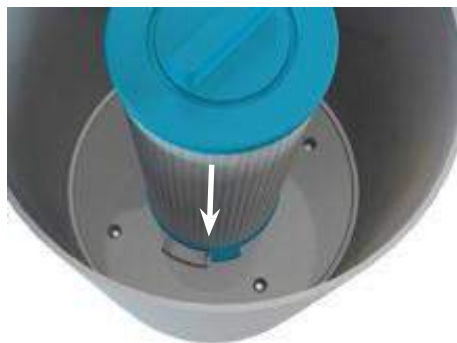

304	×1
105	×2

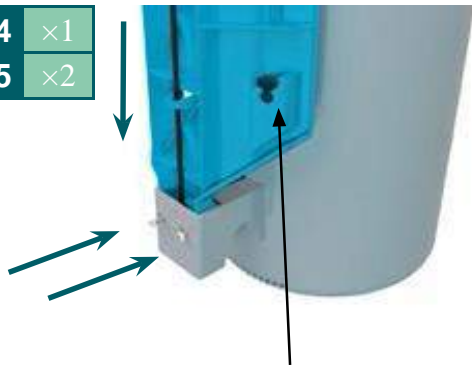

2

305	×1
307	×1



306	×1
308	×1
309	×4



(308)
(306).

4

(309)

(306)



40



50



58

VIII.5

- $\frac{1}{2} \times \frac{1}{3} = \frac{1}{6}$;
- $\frac{1}{2} \times \frac{2}{3} = \frac{1}{3}$;
- $\frac{1}{2} \times \frac{3}{3} = \frac{1}{2}$;
- $\frac{1}{2} \times \frac{4}{3} = \frac{2}{3}$;
- $\frac{1}{2} \times \frac{5}{3} = \frac{5}{6}$;
- $\frac{1}{2} \times \frac{6}{3} = 1$;
- $\frac{1}{2} \times \frac{7}{3} = \frac{7}{6}$;
- $\frac{1}{2} \times \frac{8}{3} = \frac{4}{3}$;
- $\frac{1}{2} \times \frac{9}{3} = \frac{3}{2}$;
- $\frac{1}{2} \times \frac{10}{3} = \frac{5}{3}$;
- $\frac{1}{2} \times \frac{11}{3} = \frac{11}{6}$;
- $\frac{1}{2} \times \frac{12}{3} = 2$;
- $\frac{1}{2} \times \frac{13}{3} = \frac{13}{6}$;
- $\frac{1}{2} \times \frac{14}{3} = \frac{7}{3}$;
- $\frac{1}{2} \times \frac{15}{3} = \frac{5}{2}$;
- $\frac{1}{2} \times \frac{16}{3} = \frac{8}{3}$;
- $\frac{1}{2} \times \frac{17}{3} = \frac{17}{6}$;
- $\frac{1}{2} \times \frac{18}{3} = 3$;
- $\frac{1}{2} \times \frac{19}{3} = \frac{19}{6}$;
- $\frac{1}{2} \times \frac{20}{3} = \frac{10}{3}$;
- $\frac{1}{2} \times \frac{21}{3} = \frac{7}{2}$;
- $\frac{1}{2} \times \frac{22}{3} = \frac{11}{3}$;
- $\frac{1}{2} \times \frac{23}{3} = \frac{23}{6}$;
- $\frac{1}{2} \times \frac{24}{3} = 4$;
- $\frac{1}{2} \times \frac{25}{3} = \frac{25}{6}$;
- $\frac{1}{2} \times \frac{26}{3} = \frac{13}{3}$;
- $\frac{1}{2} \times \frac{27}{3} = \frac{9}{2}$;
- $\frac{1}{2} \times \frac{28}{3} = \frac{14}{3}$;
- $\frac{1}{2} \times \frac{29}{3} = \frac{29}{6}$;
- $\frac{1}{2} \times \frac{30}{3} = 5$;
- $\frac{1}{2} \times \frac{31}{3} = \frac{31}{6}$;
- $\frac{1}{2} \times \frac{32}{3} = \frac{16}{3}$;
- $\frac{1}{2} \times \frac{33}{3} = \frac{11}{2}$;
- $\frac{1}{2} \times \frac{34}{3} = \frac{17}{3}$;
- $\frac{1}{2} \times \frac{35}{3} = \frac{35}{6}$;
- $\frac{1}{2} \times \frac{36}{3} = 6$;
- $\frac{1}{2} \times \frac{37}{3} = \frac{37}{6}$;
- $\frac{1}{2} \times \frac{38}{3} = \frac{19}{3}$;
- $\frac{1}{2} \times \frac{39}{3} = \frac{13}{2}$;
- $\frac{1}{2} \times \frac{40}{3} = \frac{20}{3}$;
- $\frac{1}{2} \times \frac{41}{3} = \frac{41}{6}$;
- $\frac{1}{2} \times \frac{42}{3} = 7$;
- $\frac{1}{2} \times \frac{43}{3} = \frac{43}{6}$;
- $\frac{1}{2} \times \frac{44}{3} = \frac{22}{3}$;
- $\frac{1}{2} \times \frac{45}{3} = \frac{15}{2}$;
- $\frac{1}{2} \times \frac{46}{3} = \frac{23}{3}$;
- $\frac{1}{2} \times \frac{47}{3} = \frac{47}{6}$;
- $\frac{1}{2} \times \frac{48}{3} = 8$;
- $\frac{1}{2} \times \frac{49}{3} = \frac{49}{6}$;
- $\frac{1}{2} \times \frac{50}{3} = \frac{25}{3}$;
- $\frac{1}{2} \times \frac{51}{3} = \frac{17}{2}$;
- $\frac{1}{2} \times \frac{52}{3} = \frac{26}{3}$;
- $\frac{1}{2} \times \frac{53}{3} = \frac{53}{6}$;
- $\frac{1}{2} \times \frac{54}{3} = 9$;
- $\frac{1}{2} \times \frac{55}{3} = \frac{55}{6}$;
- $\frac{1}{2} \times \frac{56}{3} = \frac{28}{3}$;
- $\frac{1}{2} \times \frac{57}{3} = \frac{19}{2}$;
- $\frac{1}{2} \times \frac{58}{3} = \frac{29}{3}$;
- $\frac{1}{2} \times \frac{59}{3} = \frac{59}{6}$;
- $\frac{1}{2} \times \frac{60}{3} = 10$;
- $\frac{1}{2} \times \frac{61}{3} = \frac{61}{6}$;
- $\frac{1}{2} \times \frac{62}{3} = \frac{31}{3}$;
- $\frac{1}{2} \times \frac{63}{3} = \frac{21}{2}$;
- $\frac{1}{2} \times \frac{64}{3} = \frac{32}{3}$;
- $\frac{1}{2} \times \frac{65}{3} = \frac{65}{6}$;
- $\frac{1}{2} \times \frac{66}{3} = 11$;
- $\frac{1}{2} \times \frac{67}{3} = \frac{67}{6}$;
- $\frac{1}{2} \times \frac{68}{3} = \frac{34}{3}$;
- $\frac{1}{2} \times \frac{69}{3} = \frac{23}{2}$;
- $\frac{1}{2} \times \frac{70}{3} = \frac{35}{3}$;
- $\frac{1}{2} \times \frac{71}{3} = \frac{71}{6}$;
- $\frac{1}{2} \times \frac{72}{3} = 12$;
- $\frac{1}{2} \times \frac{73}{3} = \frac{73}{6}$;
- $\frac{1}{2} \times \frac{74}{3} = \frac{37}{3}$;
- $\frac{1}{2} \times \frac{75}{3} = \frac{25}{2}$;
- $\frac{1}{2} \times \frac{76}{3} = \frac{38}{3}$;
- $\frac{1}{2} \times \frac{77}{3} = \frac{77}{6}$;
- $\frac{1}{2} \times \frac{78}{3} = 13$;
- $\frac{1}{2} \times \frac{79}{3} = \frac{79}{6}$;
- $\frac{1}{2} \times \frac{80}{3} = \frac{40}{3}$;
- $\frac{1}{2} \times \frac{81}{3} = \frac{27}{2}$;
- $\frac{1}{2} \times \frac{82}{3} = \frac{41}{3}$;
- $\frac{1}{2} \times \frac{83}{3} = \frac{83}{6}$;
- $\frac{1}{2} \times \frac{84}{3} = 14$;
- $\frac{1}{2} \times \frac{85}{3} = \frac{85}{6}$;
- $\frac{1}{2} \times \frac{86}{3} = \frac{43}{3}$;
- $\frac{1}{2} \times \frac{87}{3} = \frac{29}{2}$;
- $\frac{1}{2} \times \frac{88}{3} = \frac{44}{3}$;
- $\frac{1}{2} \times \frac{89}{3} = \frac{89}{6}$;
- $\frac{1}{2} \times \frac{90}{3} = 15$;
- $\frac{1}{2} \times \frac{91}{3} = \frac{91}{6}$;
- $\frac{1}{2} \times \frac{92}{3} = \frac{46}{3}$;
- $\frac{1}{2} \times \frac{93}{3} = \frac{31}{2}$;
- $\frac{1}{2} \times \frac{94}{3} = \frac{47}{3}$;
- $\frac{1}{2} \times \frac{95}{3} = \frac{95}{6}$;
- $\frac{1}{2} \times \frac{96}{3} = 16$;
- $\frac{1}{2} \times \frac{97}{3} = \frac{97}{6}$;
- $\frac{1}{2} \times \frac{98}{3} = \frac{49}{3}$;
- $\frac{1}{2} \times \frac{99}{3} = \frac{33}{2}$;
- $\frac{1}{2} \times \frac{100}{3} = \frac{50}{3}$;

IX.1

1) (; 3) ; 20 ; 4) ; 5) ;

2) ;

IX.2

4 ;





(,)

(, (,))

IV

Procopi



